

# Sealife

## Waterproof / Shockproof Digital Sports Camera



**ReefMaster Mini / SL320**



**ECOshot / SL321**

■ English

## Instruction Manual

Go to [www.sealife-cameras.com/service/manuals.html](http://www.sealife-cameras.com/service/manuals.html) for  
ENGLISH, FRANCAIS, DEUTSCH, ITALIANO and ESPANOL versions



## FCC STATEMENT

This device complies with Part 15 of the FCC Rules. Operation is subject to the following two conditions:

- (1) This device may not cause harmful interference, and
- (2) This device must accept any interference received, including interference that may cause undesired operation.

### **Note:**

This equipment has been tested and found to comply with the limits for Class B digital devices, pursuant to Part 15 of the FCC rules. These limits are designed to provide reasonable protection against harmful interference in a residential installation. This equipment generates uses and can radiate radio frequency energy and, if not installed and used in accordance with the instructions, may cause harmful interference to radio communications. However, there is no guarantee that interference will not occur in a particular installation. If this equipment does cause harmful interference to radio or television reception, which can be determined by turning the equipment off and on, the user is encouraged to try to correct the interference by one or more of the following measures:

- Reorient or relocate the receiving antenna.
- Increase the separation between the equipment and receiver.
- Connect the equipment into an outlet on a circuit different from that to which the receiver is connected.
- Consult the dealer or an experienced radio/TV technician for help.

Use of shielded cable is required to comply with Class B limits in Subpart B of Part 15 of the FCC rules.

Do not make any changes or modifications to the equipment unless otherwise specified in the manual. If such changes or modifications should be made, you could be required to stop operation of the equipment.

# READ THIS FIRST

## Trademark Information

- Microsoft® and Windows® are U.S. registered trademarks of Microsoft Corporation.
- Pentium® is a registered trademark of Intel Corporation.
- Macintosh is a trademark of Apple Computer, Inc.
- SD™ is a trademark.
- Photo Explorer and Photo Express are trademarks.
- Sealife®, ReefMaster®, moisture muncher® and Land & Sea® are registered trademarks of Pioneer Research.
- Other names and products may be trademarks or registered trademarks of their respective owners.

## Product Information

- Product design and specifications are subject to change without notice. This includes primary product specifications, software, software drivers, and user's manual. This User Manual is a general reference guide for the product.
- The product and accessories that come with your digital camera may be different from those described in this manual. This is due to the fact that different retailers often specify slightly different product inclusions and accessories to suit their market requirements, customer demographics, and geographical preferences. Products very often vary between retailers especially with accessories such as memory cards, cables, carrying cases/pouches, and language support. Occasionally a retailer will specify a unique product color, appearance, and internal memory capacity. Contact your dealer for precise product definition and included accessories.
- The illustrations in this manual are for the purpose of explanation and may differ from the actual design of your digital camera.
- The manufacturer assumes no liability for any errors or discrepancies in this user manual.
- The SeaLife digital camera has an operating system called "firmware" that controls all the camera functions. Just like computer programs are updated from time to time, SeaLife® may also release free firmware updates to further enhance the performance of the camera. Visit the SeaLife website Firmware download center on occasion and check if there are new firmware updates: [www.sealife-cameras.com/service/firmware.html](http://www.sealife-cameras.com/service/firmware.html).
- For user manual and driver updates, refer to our website, [www.sealife-cameras.com](http://www.sealife-cameras.com) or contact your dealer.

# SAFETY INSTRUCTIONS

Read and understand all **Warnings** and **Cautions** before using this product.

## Warnings

**If foreign objects or water have entered the camera, turn the power OFF and remove the batteries.**

Continued use in this state might cause fire or electric shock. Consult the store of purchase.



**If the camera has fallen or its case has been damaged, turn the power OFF and remove the batteries.**

Continued use in this state might cause fire or electric shock. Consult the store of purchase.



**Do not disassemble, change or repair the camera.**

This might cause fire or electric shock. For repair or internal inspection, ask the store of purchase.



**Do not place the camera on inclined or unstable surfaces.**

This might cause the camera to fall or tilt over, causing injury.



**Keep the batteries out of the reach of children.**

Swallowing batteries might cause poisoning. If the battery is accidentally swallowed, immediately consult a physician.



**Do not use the camera while you are walking, driving or riding a motorcycle.**

This might cause you to fall over or result in traffic accident.



## Cautions

**Insert the batteries paying careful attention to the polarity (+ or -) of the terminals.**

Inserting the batteries with its polarities inverted might cause fire and injury, or damage to the surrounding areas due to the battery rupturing or leaking.



**Do not fire the flash close to anyone's eyes.**

This might cause damage to the person's eyesight.



**Do not subject the LCD monitor to impact.**

This might damage the glass on the screen or cause the internal fluid to leak. If the internal fluid enters your eyes or comes into contact with your body or clothes, rinse with fresh water. If the internal fluid has entered your eyes, consult a physician to receive treatment.



**A camera is a precision instrument. Avoid drops, impact or excessive force when handling the camera.**

This might cause damage to the camera.



**Do not remove the battery immediately after long period of continuous use.**

The battery becomes hot during use. Touching a hot battery might cause burns.



**Do not wrap the camera or place it in cloth or blankets.**

This might cause heat to build up and deform the case, resulting in fire. Use the camera in a well-ventilated place.



**Do not leave the camera in places where the temperature may rise significantly, such as inside a car.**

This might adversely affect the case or the parts inside, resulting in fire.



**Before you move the camera, disconnect cords and cables.**

Failure to do this might damage cords and cables, resulting in fire and electric shock.



## Notes on Battery Usage

When you use the battery, carefully read and strictly observe the ***Safety Instructions*** and the notes described below:

- Use only the following AA batteries:
  - SeaLife Nickel Metal Hydride (Ni-MH) rechargeable batteries. Carefully follow charging instructions. Using rechargeable batteries is most cost effective and helps save our environment.
  - Lithium non-rechargeable batteries. Lithium batteries last the longest of all batteries but they are expensive and they are not rechargeable.
  - High-energy alkaline batteries.
- Avoid using the battery in extremely cold environments as low temperatures can shorten the battery life and reduce camera performance.
- The battery may feel warm after long period of continuous use of the camera or the flash. This is normal and not a malfunction.
- The camera may feel warm after long period of continuous use. This is normal and not a malfunction.
- If the camera is not to be used for a long period of time, remove the battery from the camera to prevent leakage or corrosion.
- Always keep the battery terminals in a clean state.
- Dispose of used batteries according to the battery maker instructions.

## Notes on Waterproof Function

- Do not place the camera directly on the sand at the beach or similar places.
- The camera will sink if dropped in water, so be sure to attach the strap and slip the strap over your wrist when using the camera in or near water.
- The silicone o-ring (located on the inside of the waterproof door) must be perfectly clean before each use. Refer to important o-ring care instructions in this manual.
- Be sure to check that the waterproof door is securely locked before using the camera in an environment where it is likely to get wet or dirty, such as underwater or at the beach. Water, sand or dirt inside the camera may cause failure of the camera. Wipe off any water or dirt with a dry cloth as soon as possible after using the camera.
- Avoid opening the battery/SD card cover at the beach or by the sea. Wait until the camera is completely dry before changing the batteries or the SD memory card. Avoid changing the batteries or card where the camera is likely to get wet or dirty, and make sure that your hands are dry.
- If the camera is very dirty or after it has been used in the sea, make sure that it is turned off and the waterproof door is firmly closed before rinsing it under running tap water or leaving it in a bowl of clean water for a short time (2 or 3 minutes)
- Avoid getting sunscreen or sun oil on the camera as it may cause discoloration of the surface. If any oil gets on the camera, wash it off immediately with warm water.
- The waterproof function does not apply to the camera's accessories.



# Contents

<b>INTRODUCTION</b> .....	<b>10</b>
Overview.....	10
Package Contents .....	11
<b>GETTING TO KNOW YOUR CAMERA</b> .....	<b>12</b>
Front View .....	12
Rear View .....	13
LCD Monitor Information .....	14
<b>PREPARING THE CAMERA</b> .....	<b>16</b>
Installing the Batteries .....	16
Inserting and Removing an SD Memory Card (Optional Accessory) .....	17
Attaching the Camera Strap .....	18
<b>GETTING STARTED</b> .....	<b>19</b>
Turning the Power On/Off.....	19
Choosing the Screen Language .....	20
Setting the Date and Time.....	21
Formatting an SD Memory Card or Internal Memory .....	22
<b>PHOTOGRAPHY MODE</b> .....	<b>23</b>
Shooting Images - The Basics.....	23
Setting Image Resolution and Quality .....	24
Using the Zoom Function .....	26
Setting Focus.....	27
Using the Flash.....	28
Using the Flash in External Flash Mode.....	29
Using the Self-Timer.....	30
Adjusting the Exposure (EV Compensation) .....	31
Setting White Balance .....	32
Setting White Balance in SEA mode .....	33
Setting Manual White Balance .....	34
Scene Mode Selection.....	35
About Spy Mode .....	36

<b>PLAYBACK MODE - THE BASICS.....</b>	<b>37</b>
Viewing Images .....	37
Magnifying Images .....	38
Thumbnail Display .....	39
Slideshow Display .....	40
<b>VIDEO MODE.....</b>	<b>41</b>
Recording Video Clips .....	41
Playing Back Video Clips.....	42
<b>PLAYBACK MODE - ADVANCED FEATURES.....</b>	<b>43</b>
Deleting Images/Video Clips .....	43
Protecting Images/Video Clips .....	45
Setting the DPOF .....	47
Connecting to a PictBridge Compliant Printer .....	49
<b>TAKING UNDERWATER PICTURES.....</b>	<b>51</b>
Maintaining a waterproof seal.....	52
How to Install and Remove O-ring.....	55
How to Install Deflector.....	56
Using and cleaning camera underwater .....	58
Great Underwater Pictures Made Easy .....	59
<b>TRANSFERRING FILES FROM YOUR DIGITAL CAMERA TO COMPUTER .....</b>	<b>61</b>
Step 1: Connect the digital camera to your computer .....	62
Step 2: Download images or video clips.....	63
<b>EDITING SOFTWARE INSTALLATION .....</b>	<b>64</b>
Installing Photo Explorer.....	64
Installing Photo Express .....	65
<b>USING THE DIGITAL CAMERA AS A PC CAMERA .....</b>	<b>66</b>
Step 1: Install the PC camera driver.....	66
Step 2: Connect the digital camera to your computer .....	67

<b>MENU OPTIONS</b> .....	<b>68</b>
Camera Menu.....	68
Video Menu .....	71
Playback Menu .....	72
Setup Menu .....	73
<b>SPECIFICATIONS</b> .....	<b>75</b>
<b>TROUBLESHOOTING</b> .....	<b>76</b>

# INTRODUCTION

## Overview

Let the Land & Sea adventures begin with your new SeaLife waterproof/shockproof digital camera. Equipped with the latest digital technology means the camera is automatic and easy to use. Here are some of the unique features that you will surely enjoy.

- **Land & Sea® Exposure Modes**  
Special exposure programs for taking bright, colorful underwater pictures with external flash accessory (Ext Flash accessory mode) or without flash accessory (Sea mode)
- **SPY mode**  
Sets camera to automatically take continuous images at pre set time intervals.
- **6.0 Megapixels**  
A high-resolution CCD sensor provides 6.0 megapixels for high quality images.
- **Auto flash**  
An auto flash sensor automatically detects the shooting (lighting) conditions and determines whether the flash should be used.
- **2.0" LTPS color image LCD monitor**
- **Digital zoom: 1x~4x**
- **16MB internal (built-in) memory (14MB available for image storage)**  
Images can be captured without using a memory card.
- **Support for SD memory card for memory expansion up to 1 GB**  
Recommend using only SanDisk, Panasonic or Toshiba brand SD cards.
- **USB connection (USB 2.0 compliant)**  
Still images, video clips, or voice recording files that you have recorded can be downloaded to your computer using the USB cable.
- **DPOF functionality**  
DPOF can be used to print your images on a DPOF compatible printer by simply inserting the memory card.
- **PictBridge support**  
You can connect the camera directly to a printer that supports PictBridge and perform image selection and printing using the camera monitor screen and controls.
- **Scene mode**  
You may select a previously set recording mode for the following situations: Auto, Sport, Night, Portrait, Landscape, Backlight, Sea, Ext. Flash, or Spy.
- **Provided editing software: Photo Explorer / Photo Express**  
You can enhance and retouch your images on your computer by using the provided editing software.

## Package Contents

Carefully unpack your kit box and ensure that you have the following items. In the event that any item is missing or if you find any mismatch or damage, promptly contact your dealer.

### Common Product Components:

- Digital Camera
- Camera Strap
- Camera Pouch
- 2 x AA Alkaline batteries
- 1 x Desiccant capsule
- User's Manual
- USB Cable
- Software CD-ROM
- Deflector (for optional flash accessory)
- Spare Oring (item # SL32018)

### Common (Optional) Accessories:

- SD memory card
- Rechargeable AA batteries
- SeaLife Mini Wide Angle lens (item # SL973)
- SeaLife Digital flash (item # SL960D)
- Moisture Muncher® desiccant capsules



#### NOTE

- For a complete listing of all optional accessories, please visit an authorized SeaLife dealer or the website [www.SeaLife.cameras.com](http://www.SeaLife.cameras.com).
- Accessories and components may vary by retailer.

# GETTING TO KNOW YOUR CAMERA

## Front View

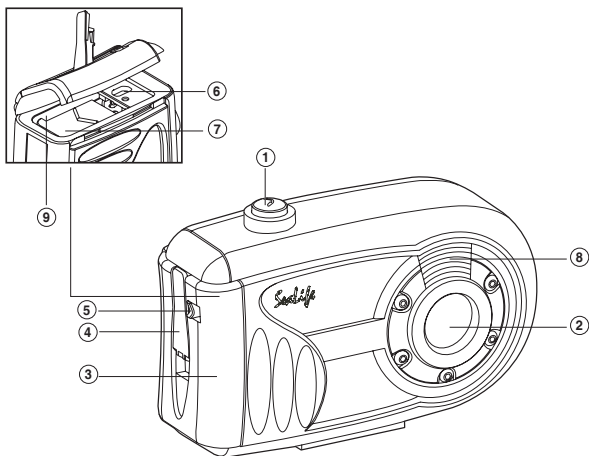

1. Shutter button \_\_\_\_\_
2. Lens \_\_\_\_\_
3. Waterproof door \_\_\_\_\_
4. Latch \_\_\_\_\_
5. Latch lock \_\_\_\_\_
6. PC/USB terminal \_\_\_\_\_
7. Battery cover \_\_\_\_\_
8. Flash \_\_\_\_\_
9. SD memory card slot \_\_\_\_\_

## Rear View

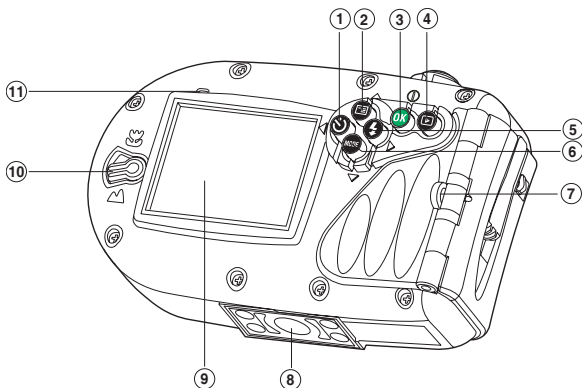



- |   |   |
|---|---|
| 1. ◀ Arrow button (Left)<br>☺ Self-timer button           | 6. ▼ Arrow button (Down)<br><b>MODE</b> button    |
| 2. ▲ Arrow button (Up)                                    | 7. Strap holder                                   |
| 3. <b>OK</b> button<br>Power switch / Digital zoom button | 8. Tripod socket                                  |
| 4. ▶ Playback button                                      | 9. LCD monitor                                    |
| 5. ▶▶ Arrow button (Right)<br>⚡ Flash button              | 10. Focus switch<br>🌸 Macro mode<br>▲ Normal mode |
|   | 11. Status LED                                    |





# LCD Monitor Information

## ■ Camera Mode





1. Internal memory/SD memory card indicator

[  ] Status of internal memory  
 [  ] Status of SD memory card

2. Remaining battery status





[  ] Full battery power  
 [  ] Medium battery power  
 [  ] Low battery power  
 [  ] No battery power

3. Flash mode

[ **Blank** ] Auto  
 [  ] Red-eye Reduction  
 [  ] Forced Flash  
 [  ] Flash Off  
 [  ] Macro Flash  
 [  ] Far Flash

4. Focus area

5. Image size

[  ] 2816 x 2112  
 [  ] 2272 x 1704  
 [  ] 1600 x 1200  
 [  ] 640 x 480



6. Possible number of shots

7. Quality

[  ] Fine  
 [  ] Standard  
 [  ] Economy

8. Date and time

9. Self-timer icon



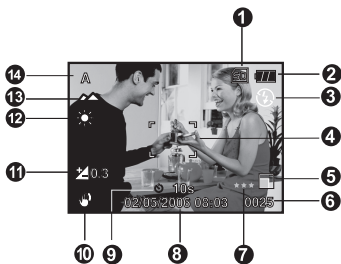

[  ] 10 sec.  
 [  ] 2 sec.  
 [  ] 10+2 sec.

10. Unsteady hold warning icon

11. [  ] Exposure compensation









12. White balance

[ **Blank** ] Auto  
 [  ] Daylight  
 [  ] Cloudy  
 [  ] Tungsten  
 [  ] Fluorescent  
 [  ] Manual WB  
 [ < 25ft/8m ] Underwater less than 25ft/8m  
 [ > 25ft/8m ] Underwater greater than 25ft/8m

13. Focus mode

[  ] Macro  
 [  ] Normal

14. Scene mode

[ **A** ] Auto  
 [  ] Sport  
 [  ] Night  
 [  ] Portrait  
 [  ] Landscape  
 [  ] Backlight  
 [  ] Sea  
 [  ] Ext. Flash  
 [  ] Spy



### ■ Video Mode

1. Video mode
2. Recordable movie time available
3. SD memory card indicator (if present)
4. Battery power indicator
5. Focus area



### ■ Image Playback

1. Playback mode
2. SD memory card indicator (if present)
3. Battery power indicator
4. Playback information



### ■ Video Playback

1. Playback mode
2. Video mode
3. Total of recorded time
4. SD memory card indicator (if present)
5. Battery power indicator
6. Playback indicator
7. Playback information



# PREPARING THE CAMERA

## Installing the Batteries

Use 2 AA size batteries to power the camera. Make sure that the power of the digital camera is off before removing the batteries.

1. Slide the latch lock to unlock the latch and open the waterproof door as shown in the illustration.
2. Open the inside battery cover and insert the batteries in the correct orientation as shown in the illustration.
3. Close both the battery cover and waterproof door and lock the latch.
  - To remove the batteries, turn the camera off before removing batteries and hold the camera with the waterproof door facing sideways, then open the door.

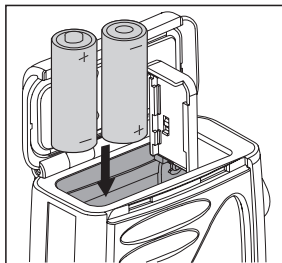
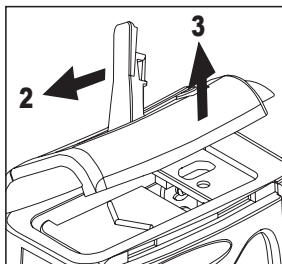
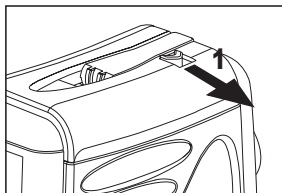

**NOTE**

- **Important:** Make sure that you and the camera are dry before opening the waterproof door.
- Be careful not to drop the batteries when opening or closing the battery cover.
- Opening the waterproof door with the camera held sideways will prevent water drops from entering the internal electronic areas.

## Inserting and Removing an SD Memory Card (Optional Accessory)

The digital camera comes with 16MB of internal memory (14MB available for image storage), allowing you to store captured still images or video clips in the digital camera. It is recommended to expand the memory capacity by using an optional SD (Secure Digital) memory card so that you can store more files.

1. Make sure your camera is turned off before inserting or removing a memory card.
2. Open the waterproof door and then the inside battery cover.
3. Insert an SD memory card in the correct orientation as shown in the illustration.
4. Close both the battery and battery/SD card covers and lock the latch.
  - To remove the SD memory card, make sure the camera is turned off. Press lightly on the edge of the memory card and it will eject.

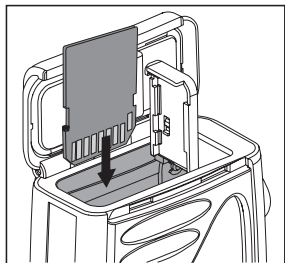

**Important:** Use only SanDisk, Panasonic or Toshiba brand SD memory cards up to 1GB in size. Other brands and larger SD Memory cards may work fine but their compatibility and performance can not be guaranteed with the camera.



**NOTE**

- Be sure to format an SD memory card with this digital camera before using it. Refer to section in the manual titled “**Formatting an SD Memory Card or Internal Memory**” for further details.
- To prevent valuable data from being accidentally erased from an SD card, you can slide the write protect tab (on the side of the SD memory card) to “LOCK”.
- To save, edit, or erase data on an SD memory card, you must unlock the card.

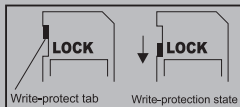

## Attaching the Camera Strap

Attach the strap as shown in the illustration.

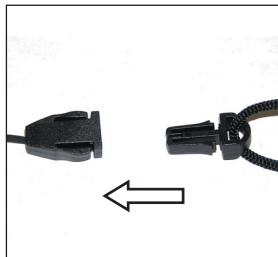

## LED Indicators

Color	State	During photography	During connection to a PC
Green	Solid	Ready for shot.	System ready.
Green	Flashing	Accessing files in progress. Flash charging in progress.	Accessing files in progress.

# GETTING STARTED

## Turning the Power On/Off

Load the batteries and insert an SD memory card before starting.

- To turn the power on, push and hold the **OK** button until the camera turns on.
- To turn the power off, push and hold the **OK** button until the camera turns off.

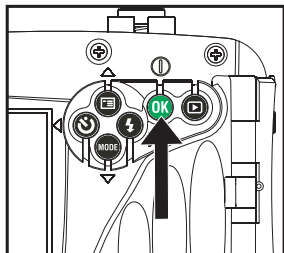

### NOTE

- The power is turned off automatically when the camera has not been operated for a fixed period time. To resume the operation condition, turn the power on again. Refer to section in this manual titled "Auto Off" in the Setup Menu for further details.

## Choosing the Screen Language

Follow the steps below to choose the desired language.

1. Push and hold the **OK** button until the camera turns on.
  - The camera mode (default preview) is displayed.
2. Press the **▲ / [ ]** button and access the setup menu with the **▶** button.
  - In the video [**+**] mode or playback [**▶**] mode, you may also follow the step above to access the setup menu.
3. Select [Language] with the **▲ / ▼** buttons, then press the **OK** button.
  - The Language setting screen will be displayed.
4. Select the displayed language with the **▲ / ▼** buttons, then press the **OK** button.
  - The setting will be stored.
5. To exit from the menu, press continuously the **◀** button.

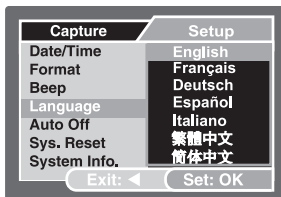
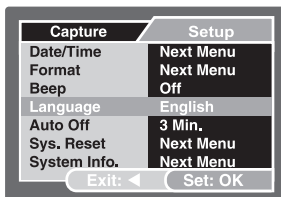

Ex.: In Camera Mode

## Setting the Date and Time

Follow the steps below to set the date display style, current date and time.

1. Push and hold the **OK** button until the camera turns on.
  - The camera mode (default preview) is displayed.
2. Press the **▲** / **☰** button and access the setup menu with the **▶** button.
  - In the video **[V]** mode or playback **[▶]** mode, you may also follow the step above to access the setup menu.
3. Select **[Date/Time]** with the **▲** / **▼** buttons, then press the **OK** button.
  - The Date/Time setting screen will be displayed.
4. Select the item's field with the **◀** / **▶** buttons and adjust the value for the date and time with the **▲** / **▼** buttons.
  - The date and time is set in the order year-month-day-hour-minute.
  - The time is displayed in 24-hour format.
5. After confirming all settings are correct, press the **OK** button.
6. To exit from the menu, press continuously the **◀** button.

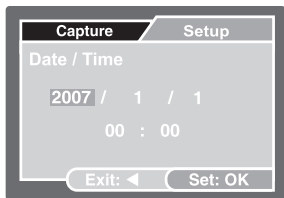
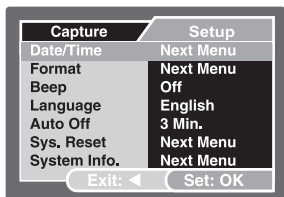

Ex.: In Camera Mode

## Formatting an SD Memory Card or Internal Memory

The term “Formatting” means preparing an “SD Memory Card” to record images; this process is also called “initialization”. This utility formats the internal memory (or memory card) and erases all stored images and data.

1. Push and hold the **OK** button until the camera turns on.
  - The camera mode (default preview) is displayed.
2. Press the **▲ / [ ]** button and access the setup menu with the **▶** button.
  - In the video **[ ]** mode or playback **[ ]** mode, you may also follow the step above to access the setup menu.
3. Select [Format] with the **▲ / ▼** buttons, then press the **OK** button.
4. Select [Execute] with the **▲ / ▼** buttons, then press the **OK** button.
  - To cancel formatting, select [Cancel] and press the **OK** button.
5. To exit from the menu, press continuously the **◀** button.

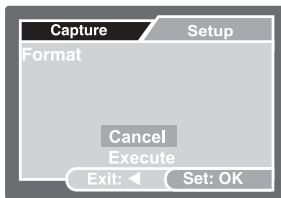
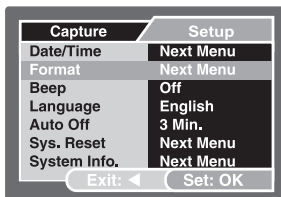

Ex.: In Camera Mode



- It is highly recommended to format the SD memory card when the card is first installed; or when the card is used in another device; or on a regular basis.
- When you format an SD memory card, be aware that all data of which will be permanently erased. Protected images are also erased.
- To format the internal memory, do not insert a memory card into the camera. Otherwise, you will format the memory card.
- Formatting is an irreversible action and data cannot be recovered at a later time.
- An SD memory card having any problem cannot be properly formatted.



# PHOTOGRAPHY MODE

## Shooting Images - The Basics

1. Push and hold the **OK** button until the camera turns on.
  - The camera mode (default preview) is displayed.
2. Compose the image on the monitor screen so that the main subject is within the focus frame.
3. Press the shutter button to capture the image.



### NOTE

- The actual captured image appears to be larger than the one on LCD after image captured.

## Setting Image Resolution and Quality

As you get to know the digital camera, you can set the image resolution (number of vertical and horizontal pixels) and image quality (compression ratio) based on the types of images you want to shoot. These settings affect the number of images that can be stored in memory, or on a memory card.

Higher resolution and higher quality images provide finer detail but cause the images file size to be larger.

To change image resolution or image quality, perform these steps below:

1. Push and hold the **OK** button until the camera turns on.
  - The camera mode (default preview) is displayed.
2. Press the **▲** /  button.
  - The [Capture] menu is displayed.
3. Select [Size] with the **▲** / **▼** buttons, then press the **OK** button.
4. Select the desired setting with the **▲** / **▼** buttons, then press the **OK** button.
5. Select [Quality] with the **▲** / **▼** buttons, then press the **OK** button.
6. Select the desired setting with the **▲** / **▼** buttons, then press the **OK** button.
7. To exit from the menu, press the **◀** button.

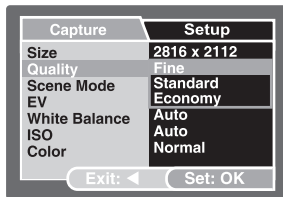
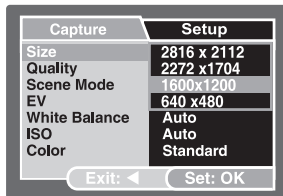





### NOTE

- The possible number of shots and recording time depend on the storage size, resolution and quality settings and the subject of the image to be captured.

## ■ Possible Number of Recordable Images

The frame counter indicates the approximate number of images that can be stored on the SD memory card. The number of recordable images may vary depending on the recorded subject, the capacity of the memory card, there are files other than images or when the recording is made while switching the picture quality or resolution.

Resolution	Quality (Compression Ratio)	SD Memory Card						
		14MB Internal Memory	32MB	64MB	128MB	256MB	512MB	1GB
2816 x 2112 	*** Fine (1/4)	3	8	17	36	74	150	301
	** Standard (1/8)	6	14	29	61	124	251	503
	* Economy (1/16)	11	27	57	116	239	482	969
2272 x 1704 	*** Fine (1/4)	5	12	26	54	111	224	449
	** Standard (1/8)	9	21	44	91	186	375	752
	* Economy (1/16)	17	40	86	176	358	721	1447
1600 x 1200 	*** Fine (1/4)	9	21	46	94	191	385	774
	** Standard (1/8)	15	36	76	158	320	645	1294
	* Economy (1/16)	29	69	148	304	616	1241	2491
640 x 480 	*** Fine (1/4)	30	71	151	310	628	1265	2539
	** Standard (1/8)	50	119	252	518	1051	2117	4248
	* Economy (1/16)	96	229	485	998	2022	4073	8147

- \* The above data shows the standard testing results. The actual capacity varies according to the shooting conditions and settings.

## ■ Approximate Duration of Recording Time

Image size	SD Memory Card						
	14MB Internal Memory	32MB	64MB	128MB	256MB	512MB	1GB
320 x 240	00:00:23	00:00:51	00:01:44	00:03:31	00:07:05	00:14:12	00:28:28

- \* The values for the recording time may vary depending on the shooting conditions and settings.

## Using the Zoom Function

This camera is equipped with 4x digital zoom. You can enlarge the subjects by pressing continuously the **OK** button. A useful feature as it is, however, the more the image is magnified, the grainier the image may become.

To capture a zoomed image, perform the following steps:

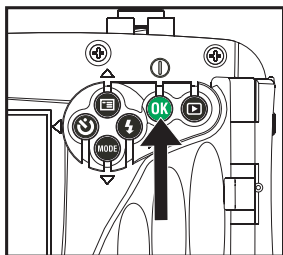

1. Push and hold the **OK** button until the camera turns on.
  - The camera mode (default preview) is displayed.
2. To activate the digital zoom, push and release the **OK** button.
  - Each push and release of the **OK** button will increase the Zoom up to 4X.
  - The status of digital magnification is displayed on the LCD monitor.
3. Compose your scene and press the shutter button to capture the image.



### NOTE

- The digital magnification ranges from 1.0x to 4.0x.
- As you record video clips, the zoom function cannot be activated.



## Setting Focus

Images can be captured by sliding the focus switch to set the focus modes:  macro or  normal mode.

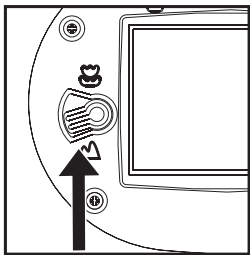
1. Push and hold the **OK** button until the camera turns on.
  - The camera mode (default preview) is displayed.
2. Slide the focus switch to your desired focus mode.
3. Compose your scene and press the shutter button.



The table below will help you choose the appropriate focus mode:

Focus mode	Description
 Normal	This mode is suitable for shooting distance of 3ft/1m to infinity.
 Macro	Select macro to capture close-up images at shooting distance of 2ft/60cm to 3ft/1m.



### NOTE

- Underwater focus range will vary because of the water's magnification effect. Normal focus range is 2.5ft/75cm to infinity. Macro focus is 1.5ft/45cm to 2.5ft/75cm.



## Using the Flash

The flash is designed to function automatically when lighting conditions warrant the use of flash. The camera has four flash modes: Auto Flash (default), Red Eye, Forced Flash and No Flash. You can take an image using a desired flash mode to suit your circumstances.

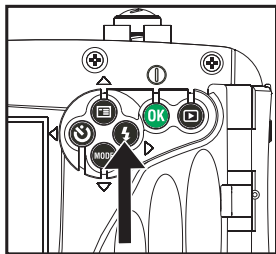
1. Push and hold the **OK** button until the camera turns on.
  - The camera mode (default preview) is displayed.
2. Toggle the **▶ / ⚡** button until your desired flash mode appears on the LCD monitor.
3. Compose your scene and press the shutter button.





The table below will help you to choose the appropriate flash mode:

Flash mode	Description
Auto	The flash fires automatically according to the photographic conditions.
 Red-eye Reduction	Use this mode to reduce the red-eye phenomenon when you want to take natural-looking photographs of people and animals in low-light conditions. When taking photographs, the red-eye phenomenon can be reduced by asking the subject (person) to look at the digital camera or get as close to the digital camera as possible.
 Forced Flash	The flash will always fire regardless of the surrounding brightness. Select this mode for recording images with high contrast (backlighting) and deep shadows.
 Flash Off	Use this mode when the flash use is prohibited or under the situation that the distance to the subject is too far away for the flash to have any effect.

## Using the Flash in External Flash Mode

When the camera's Scene mode is set to Ext. Flash, the camera's flash is set to Forced Flash and will always fire. When the camera's flash fires, it will automatically fire the optional External Flash accessory. Refer to the SeaLife Flash instruction manual for detailed operating instructions about the optional external flash accessory. Refer to the section in this manual titled "Scene Mode Selection" for more information about selecting the Ext. Flash Scene mode.

In order to achieve proper image exposure, it may be necessary to select from one of the following three flash modes:

- |   |  |
|---|--|
| [Blank] -   | This is the default setting ideal for proper exposure from 1 yd (1m) to 2 yd (2m). |
|  - Macro Flash | This flash setting is ideal for shooting distances inside of 1 yd. (1m).           |
|  - Far Flash   | Select this flash mode for best exposure beyond 2 yds(2m) shooting distance.       |



### NOTE

- The above shooting distance may vary depending on water visibility and the reflectivity of the subject. Experiment with different flash modes and adjust accordingly.
- Press the  flash button and select the appropriate flash mode.
- To further brighten or darken the images, adjust the exposure compensation.

## Using the Self-Timer

The self-timer can be used in situations such as group shots. When using this option, you should either mount the camera on a tripod (recommended) or rest it on a flat, level surface.

1. Secure the camera to a tripod or place it on a stable surface.
2. Press and hold the **OK** button until the camera turns on.
  - The camera mode (default preview) is displayed.
3. Toggle the **◀ / ⏻** button until your desired self-timer mode appears on the LCD monitor.

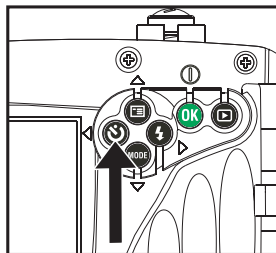
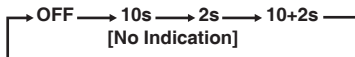

4. Compose your scene and press the shutter button.
  - The self-timer function is activated.
  - The photography is then taken after the preset time.
  - To cancel the self-timer at any time, press the **◀ / ⏻** button to disrupt the sequence.



### NOTE

- After one shot is taken, the self-timer mode is turned off.
- If you wish to take another image using the self-timer, repeat these steps.



## Adjusting the Exposure (EV Compensation)

You can manually adjust the exposure determined by the digital camera. Use this mode when the proper exposure cannot be obtained, for example, when the contrast (different between light and dark) between the subject and the background is extremely large. The EV compensation value can be set in the range from -2.0EV to +2.0EV.

1. Push and hold the **OK** button until the camera turns on.
2. Toggle the **▼ / MODE** button and switch to camera or [📷] mode.
3. Press the **▲ / [📷]** button.
  - The [Capture] or [Video Output] menu is displayed.
4. Select [EV] with the **▲ / ▼** buttons, then press the **OK** button.
5. Use **▲** or **▼** button to set the range of EV compensation value from -2.0EV to +2.0EV, then press the **OK** button.
6. To exit from the menu, press the **◀** button.

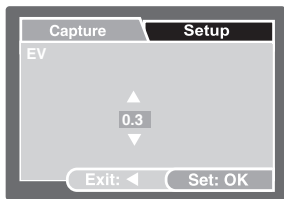
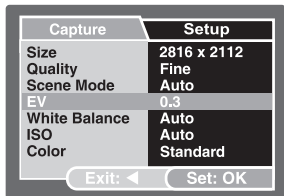

Ex.: In Camera Mode

## Setting White Balance

This feature lets you make adjustments to compensate for different lighting types according to your shooting conditions. The camera will automatically select the best setting when in AUTO White Balance. If the picture colors are off, select the White Balance for the specific lighting type.

1. Push and hold **OK** button until the camera turns on.
2. Toggle the **▼ / MODE** button and switch to camera or video [📷] mode.
3. Press the **▲ / [📷]** button.
  - The [Capture] or [Video Output] menu is displayed.
4. Select [White Balance] with the **▲ / ▼** buttons, then press the **OK** button.
5. Select the desired setting with the **▲ / ▼** buttons, then press the **OK** button.
6. To exit from the menu, press the **◀** button.

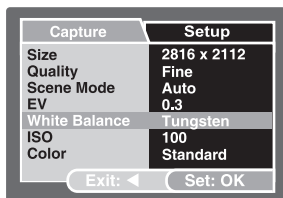
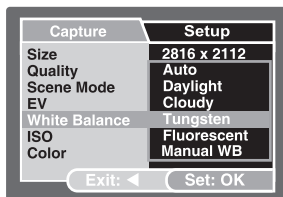

Ex.: In Camera Mode

## Setting White Balance in SEA mode

In SEA mode, the following white balance options are displayed: Auto, < 25ft/8m, > 25ft/8m, manual. The camera default setting in SEA mode is < 25ft/8m. You will notice that the LCD display image has a red color tint on land. This is normal and will not appear red while underwater.



### NOTE

- In External flash mode the white balance is calibrated to the color temperature of the External Flash (Optional Accessory). You should not make any white balance adjustments when in Ext. Flash mode.

## Setting Manual White Balance

You can manually set and store the white balance when the menu options does not offer a good match.

1. Push and hold the **OK** button until the camera turns on.
2. Push the **▲ / [Menu]** button.
  - The [Capture] menu is displayed.
3. Select [White Balance] with the **▲ / ▼** buttons, then push the **OK** button.
4. Select [Manual WB] with the **▲ / ▼** buttons, then push the **OK** button.
5. Point the camera at a 8.5" x 11" (A4) sheet of white paper (or white slate). Hold the paper (or slate) at arms length and push the **OK** button to [Execute]. The Manual White Balance is now stored in the camera.
6. To cancel the white balance setting, repeat the above process and select [Cancel] in Step 5.

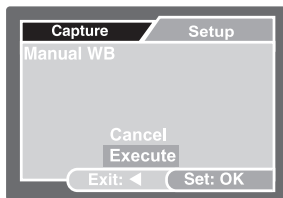
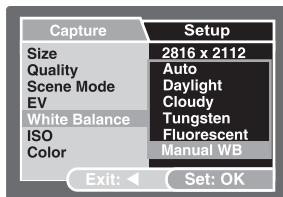

Ex.: In Camera Mode











### NOTE

- It may be helpful to hold the paper (or slate) at an angle, midway between the light source and the camera.

## Scene Mode Selection

You can select the scene mode according to the shooting scene. There are 9 available scene modes.

- [ **A** ] Auto: Select this mode to adjust point-and-shoot action.
- [  ] Sport: Select this mode when you want to photograph fast-moving subjects.
- [  ] Night: Select this mode when you want to take pictures outdoors at night.
- [  ] Portrait: Select this mode when you want to capture an image that makes the person stand out against the background.
- [  ] Landscape: Select this mode to capture an image with hard sharpness and high saturation.
- [  ] Backlight: Select this mode when you want to capture images when the light comes from behind the object.
- [  ] Sea: Select this mode when you want to capture underwater photos when NOT using optional external flash accessory.
- [  ] Ext. Flash: Select this mode when you want to capture underwater photos when using optional external flash accessory.
- [  ] Spy: For continuous pictures at set time intervals.

1. Push and hold the **OK** button until the camera turns on.
  - The camera mode (default preview) is displayed.
2. Press the **▲ / [Menu]** button.
  - The [Capture] menu is displayed.
3. Select [Scene Mode] with the **▲ / ▼** buttons, then press the **OK** button.
4. Select the desired scene mode with the **▲ / ▼** buttons, then press the **OK** button.
5. To exit from the menu, press the **◀** button.

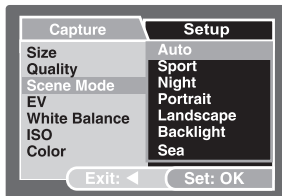
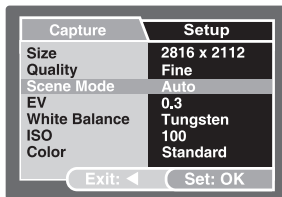

## About Spy Mode

This mode is used to capture continuous images at a preselected time interval. This mode is useful for taking a sequence of images, like a sunrise or sunset, and later selecting the best image. It is also useful for taking a series of pictures without being discovered by the subject, like a bird feeder. A compact tripod accessory is helpful to keep the camera aimed at the subject.

1. Toggle the **▼ / MODE** button to capture mode.
  - a. Press the **▲ / [ ]** button.
  - b. Select [Scene mode] with the **▲ / ▼** buttons and press the **OK** button.
  - c. Select [Spy] with the **▲ / ▼** buttons and press the **OK** button.
  - d. Select the desired time interval with the **▲ / ▼** buttons and press the **OK** button.
  - e. Press the **◀** button to exit from the menu.
2. Aim the camera at the desired subject or scene. It is preferred to use a compact tripod, so the camera is steady and remains aimed at the subject.
3. Press the shutter button. The camera will countdown from 10 seconds and take the first picture,
4. The LCD display will then turn off to save battery power. The camera will continue to take images at the preselected time interval, until:
  - a. You press the shutter button again.
  - b. The memory is full.
  - c. The battery is empty.



### NOTE

- When the interval is set to [Off], the LCD display will turn off and the camera will start taking images at a regular interval (about 3 seconds) without the countdown.

# PLAYBACK MODE - THE BASICS

## Viewing Images

You can display the still images you have just captured at a time.

1. Push and hold the **OK** button until the camera turns on.
2. Press the [▶] button.
  - The last recorded image appears on the LCD monitor.
3. Use ◀ or ▶ button to select the desired images.
  - To view the previous image, press the ◀ button.
  - To view the next image, press the ▶ button.
4. To exit from playback mode, press the [▶] or ▼ (MODE) button.



### NOTE

- The playback information displayed on the LCD monitor will disappear after seconds of time.
- If there is no image stored in the internal memory or on the memory card. [NO IMAGE] message will appear on the monitor.

## Magnifying Images

While reviewing your images, you may enlarge a selected portion of an image. This magnification allows you to view fine details. The zoom factor displayed on the screen shows the current magnification ratio.

1. Push and hold the **OK** button until the camera turns on.
2. Press the **[L]** button.
  - The last recorded image appears on the LCD monitor.
  - To view the previous image, press the **◀** button.
  - To view the next image, press the **▶** button.
3. Continuously push and release the **OK** button to zoom in on the picture.
  - The magnification factor is displayed on the LCD monitor.
4. To view different portion of the images, press the **▲ / ▼ / ◀ / ▶** button to adjust the display area.



### NOTE

- The magnification factors range from 1x to 4x (within 7 stages: 1.0x, 1.5x, 2.0x, 2.5x, 3.0x, 3.5x and 4.0x).



## Thumbnail Display

This function allows you to view 9 thumbnail images on the LCD monitor simultaneously so you may search for a particular image.

1. Push and hold the **OK** button until the camera turns on.
2. Press the [▶] button.
  - The last recorded image appears on the LCD monitor.
3. Continuously push and release the **OK** button until the thumbnail images are displayed.
  - For recorded video clips, the [▶] video mode icon will be displayed.
4. Use the ▲ / ▼ / ◀ / ▶ button to move the cursor to select the image to be displayed at regular size.
5. Press the **OK** button to display the selected image on full screen.









- If the first displayed file is a video clip, use ◀ / ▶ buttons to select an image file, then press continuously the **OK** button to display the thumbnail.



- In playback [▶] mode, you may also display the thumbnail by the following steps:
  1. Press the ▲ / [▶] button to access the playback menu.
    - The playback menu is displayed.
  2. Select [Thumbnail] with the ▲ / ▼ buttons, then press the **OK** button.

## Slideshow Display

The slide show function enables you to play your images back automatically in sequential order. This is very useful and entertaining feature for reviewing recorded images and for presentations.

1. Press the  button.
2. Press the  button.
  - The playback menu is displayed.
3. Select [Slide Show] with the  /  buttons, then press the **OK** button.
4. Use  /  to select the playback interval, then press the **OK** button.
  - The slideshow starts.
5. To stop the slide show during playback, press the **OK** button.

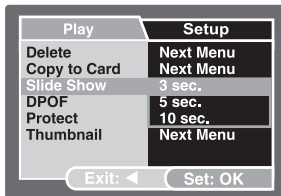
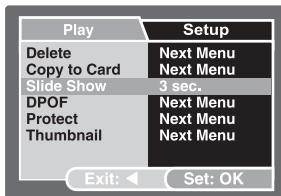

### NOTE

- You can adjust the slide show display interval within the range of 3 Sec., 5 Sec., 10 Sec.
- The Auto Off function does not operate during slide show.
- All still images in the folder are automatically played back.
- Video clips are displayed the first frame image, and they are not played back.
- Slideshow display is only activated when more than 2 images are stored in the SD card/internal memory.

# VIDEO MODE

## Recording Video Clips

This mode allows you to record video clips with sound via built-in microphone.

1. Press and hold the **OK** button until the camera turns on.
2. Press **▼** / **MODE** and switch to  mode.
3. Press the shutter button to start recording.
4. To stop recording, press the shutter button again.



### NOTE

- When recording a video clip, the flash cannot be used.
- You will need sufficient lighting for good quality video. In low light conditions, use a video light (optional accessory) to illuminate the subject.

## Playing Back Video Clips

You can play back recorded video clips. A guide to operation appears on the LCD monitor during the video playback.

1. Press the **[▶]** button.
2. Use **◀** or **▶** to go through the images until the video clip you want to play back is displayed.
  - To view the previous image, press the **◀** button.
  - To view the next image, press the **▶** button.
3. Press the **OK** button to start playing back the video clips.
  - To pause or resume video playback, press the **OK** button again.
  - Push the **MODE** button while the video clip is paused to return to the beginning of the video clip.



**NOTE**

- The playback information displayed on the LCD monitor will disappear after seconds of time.
- The zoom function cannot be activated while playing the video clips back.
- To playback the video clips on the computer, we recommend you to use Windows Media Player 9.0 (WMP 9.0) or later. You can download WMP version from the website at [www.microsoft.com](http://www.microsoft.com). If the video can't be play back in the WMP 9.0, you have to update the renewed of WMP 9.0 from the Microsoft website.

# PLAYBACK MODE - ADVANCED FEATURES

## Deleting Images/Video Clips







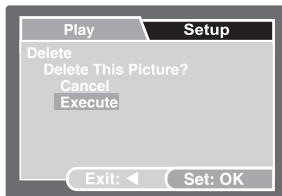
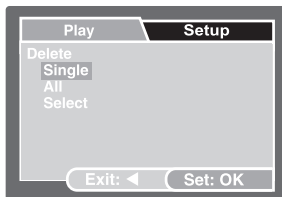
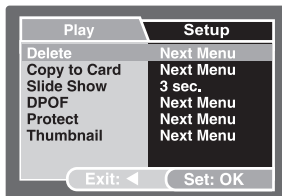



Use this function to delete one or all images/video clips stored in the internal memory or memory card. Please note that the deleted images or video clips cannot be recovered. Exercise caution before deleting a file.

### Deleting in Playback Mode

1. Press the [▶] button.
  - The last image will be displayed on the screen.
2. Select the image you want to erase with the ◀ / ▶ buttons.
3. Press the ▲ / ▢ button.
  - The playback menu is displayed.
4. Select [Delete] with the ▲ / ▼ buttons, then press the **OK** button.
  - The deletion menu is displayed.
5. Select [Single] or [All] with the ▲ / ▼ buttons, then press the **OK** button.
  - Single: Delete the displayed image or the last image.
  - All: Delete all of the images on the SDmemory card except for the protected images.
  - Select: Select the image from the thumbnail display and then delete it.
6. Select [Execute] with the ▲ / ▼ buttons, then press the **OK** button.
  - To cancel deletion, select [Cancel], then press the **OK** button.



## Deleting Selected Image

1. Press the  button.
2. Press the  /  button.
  - The playback menu is displayed.
3. Select [Delete] with the  /  buttons, then press the **OK** button.
  - The deletion menu is displayed.
4. Select [Select] with the  /  buttons, then press the **OK** button.
  - The images are displayed in the thumbnail display.
5. Select the image you want to delete with the  /  /  /  buttons, then press the **OK** button.
  - The image you've just selected has been deleted.



### NOTE

- As a shortcut, you can delete any image while in Playback mode by pushing the shutter button. This will display the [Delete This Picture?] message.

## Protecting Images/Video Clips

Set the data to read-only to prevent images from being erased by mistake.

### Protecting Images

1. Press the [▶] button.
  - The last recorded image appears on the LCD monitor.
2. Select the image that you want to protect with the ◀ / ▶ buttons.
3. Press the ▲ / [⏏] button.
  - The playback menu is displayed.
4. Select [Protect] with the ▲ / ▼ buttons, then press the **OK** button.
5. Select [Single] or [All] with the ▲ / ▼ buttons, then press the **OK** button.
  - Press continuously the ◀ button to return to the playback mode.  
The protect icon [🔒] is displayed with the protected image.
6. Select [Set] with the ▲ / ▼ buttons, then press the **OK** button.
  - When [All] has been selected, [🔒] is displayed with all the images.

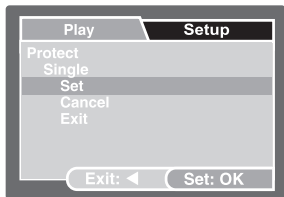
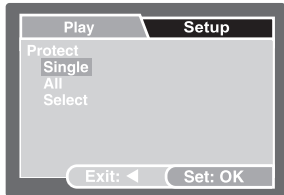
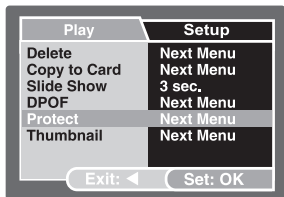

### To Cancel the Protection

To cancel protection for only one image, display the image that you want to remove the image protection.

1. Select [Protect] with the ▲ / ▼ buttons from the playback menu, then press the **OK** button.
2. Select [Single] or [All] with the ▲ / ▼ buttons, then press the **OK** button.
3. Select [Cancel] with the ▲ / ▼ buttons, then press the **OK** button.
  - Press continuously the ◀ button to return to the playback mode. The removal of image protection has been executed.

### Protecting Selected Images

1. Select [Protect] with the ▲ / ▼ buttons from the playback menu, then press the **OK** button.
2. Select [Select] with the ▲ / ▼ buttons, then press the **OK** button.
  - The images are displayed in the thumbnail display.
3. Select the image you want to protect with the ▲ / ▼ / ◀ / ▶ buttons, then press the **OK** button.
4. If you want to cancel the protection of selected image respectively, follow the steps mentioned in “**To Cancel the Protection**” above to set.



#### NOTE

- Formatting an SD memory card overrides protection, and erases all images regardless of their protected status.



## Setting the DPOF

DPOF (Digital Print Order Format) allows you to embed printing information on your memory card. By using DPOF, you can select an image to be printed and then specify how many prints or which image you would like. Take your memory card to a DPOF enabled printer that accepts memory cards. The DPOF/card-compatible printer will read the embedded information on the memory card and print your images as specified.

1. Press the [▶] button.
2. Select the image that you want to set DPOF with the ◀ / ▶ buttons.
3. Press the ▲ / [ ] button.
  - The playback menu is displayed.
4. Select [DPOF] with the ▲ / ▼ buttons, and press the **OK** button.
  - The DPOF setting screen is displayed.
5. Select [Single] or [All] with the ▲ / ▼ buttons, and press the **OK** button.
  - Single: Sets DPOF for each individual image.
  - All: Sets DPOF for all images at once.
6. Select [Print Num.] with the ▲ / ▼ buttons, and press the **OK** button.
  - This displays the number of prints setting screen.
7. Set the number of prints with the ▲ / ▼ buttons, and press the **OK** button.
  - You can set up to 9 prints for each image.
8. Select [Date Print] with the ▲ / ▼ buttons, and press the **OK** button.
  - The date setting screen appears.

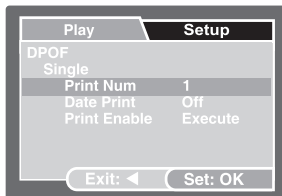
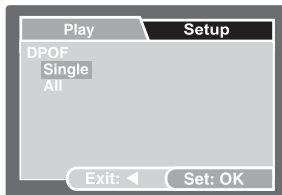
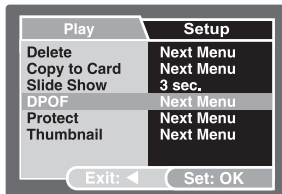

9. Select [On] or [Off] with the ▲ / ▼ buttons, and press the **OK** button.
  - On: The date of the photograph will also be printed.
  - Off: The date of the photograph will not be printed.
10. Select [Print Enable] with the ▲ / ▼ buttons, and press the **OK** button.
11. Select [Execute] with the ▲ / ▼ buttons, and press the **OK** button.
  - This creates a file containing the DPOF information, and when the operation is finished, press the ◀ button continuously to return to the playback mode.
  - The DPOF icon  is displayed on each image that has DPOF settings.



**NOTE**

- The date that is printed on the photo is the date set on the camera. To print the correct date on the photo, set the date on the camera before you photograph the image. Refer to section in this manual titled "Setting the Date and Time" for further details.
- Before you perform the DPOF settings on your camera, always remember to copy your images from the internal memory to an SD memory card first.
- You cannot print movies.

## Connecting to a PictBridge Compliant Printer

If a printer that supports PictBridge is available, images can be printed by connecting the digital still camera directly to the PictBridge-compatible printer without using a computer.

### Connecting the camera to the printer

1. Connect the USB port on the camera and the USB jack on the printer with the supplied USB cable, then turn on your camera and the printer.
  - The screen for selecting the USB mode is displayed.
2. Select [PictBridge] and press the **OK** button.

### Printing images

When the camera is properly connected to a PictBridge compliant printer, the PictBridge menu is displayed on the monitor.

1. Select the item you want to configure with the ▲ / ▼ buttons, and press the **OK** button.

- [Images]: Select whether you want to print specific image or all images. You may also select printing number for specific image.
- [Date Print]: According to the printer type, select whether you want to print the image with date imprint or not.
- [Paper Size]: Select the desired paper size according to the printer type.
- [Layout]: Select the desired printing layout according to the printer type.
- [Print]: After all settings are configured, select this item to start printing.

2. If you select [Images] in the previous step, the figure shown on the right hand side will appear. Select [Select] or [All] with the ▲ / ▼ buttons, and press the **OK** button.

- [Select]: Select to print multi images simultaneously.
- [All]: Select to print all images.
- [Exit]: Exit from Images option.

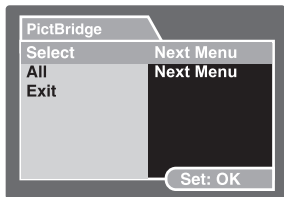
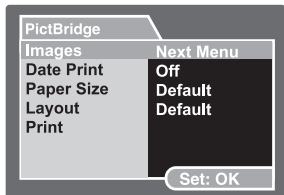

- If you select [Select] in the previous step, the figure shown on the right hand side will appear.
  - Select the multi images that you want to print simultaneously with the ◀ / ▶ buttons.
  - Select the [Print Num.] (up to 99) with the ▲ / ▼ buttons.
  - After selecting the desired image and printing number, press the **OK** button to confirm.
- Select [Print] with the ▲ / ▼ buttons, and press the **OK** button to start printing.
  - The [Complete] will be displayed temporarily, reminding you that the printing procedure is finished.
  - If a print error is detected, the [Print Error] will be displayed.

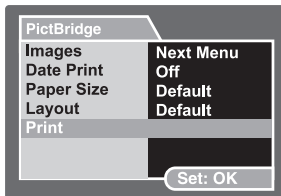
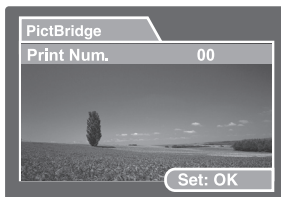

**NOTE**

- The image printing may fail if the power to the camera is cut off.

# TAKING UNDERWATER PICTURES

1. Read and understand the instructions contained in this manual before using the camera underwater.
2. Do not exceed the depth rating marked on the camera or the camera may leak.
3. Follow these important O-ring care instructions or the waterproof camera may leak.
  - Inspect and clean O-ring and O-ring contact surfaces for sand, hair and other debris before every use.
  - Inspect O-ring and O-ring contact surfaces for damage (cuts, scratches, tears, cracks, dents and any other imperfections.) Replace O-ring or have camera serviced if the O-ring or O-ring contact surfaces are damaged. Do not use camera if O-ring or O-ring contact surfaces are damaged. Replacement O-rings are available at your local authorized SeaLife dealer.
  - Make sure O-ring is completely seated into O-ring groove before sealing battery door. O-ring must not be twisted when seated in the O-ring groove. Carefully follow O-ring removal and installation instructions contained in this manual.
  - Replace O-ring every year to ensure proper seal. Only use approved SeaLife O-ring designed for the camera.
  - Soak and rinse camera in fresh water after each use. Use clean, soft cloth to dry housing. Store camera only after careful cleaning and when totally dry.
4. Carefully close waterproof door to seal camera.
  - Make sure O-ring does not slip out of the groove when sealing.
  - Make sure there are no obstructions that prevent waterproof door from sealing properly.
5. Never let any moisture or dirt get inside camera when opening.
6. For great underwater pictures you need:
  - Clear water conditions, control your buoyancy before taking pictures, get as close as possible to subject (ideal distance is 2' to 6')
  - Use SeaLife External Flash to enhance colors and reduce backscatter.
7. Store camera at room temperature in a clean and dry place.
  - Do not expose camera to direct sunlight for prolonged periods of time.
  - Do not store camera in extreme high temperatures, such as the trunk of your car.

## Maintaining a waterproof seal



### Important:

- Do NOT lubricate O-ring.
- Carefully inspect and clean O-ring and O-ring contact surfaces before each underwater use.
- If O-ring needs to be replaced, contact your local Sealife dealer or visit [www.sealife-cameras.com](http://www.sealife-cameras.com) to located a dealer near you.

## Maintaining a waterproof seal

Every SeaLife camera is tested for quality and a waterproof seal. It is your responsibility to properly care for the O-ring and O-ring contact surfaces to maintain a waterproof seal. Carefully follow these important O-ring care instructions. Not following these care instructions may cause the camera to leak and void your warranty.

1. Carefully **inspect O-ring and O-ring contact surfaces for damage** (cuts, scratches, tears, cracks, dents and any other imperfections.) **before every use.** Rub finger along O-ring and O-ring contact surfaces to inspect for damage. Replace O-ring or have camera serviced if the O-ring or O-ring contact surfaces are damaged. Do not use camera if O-ring or O-ring contact surfaces are damaged. Replacement O-rings are available at your local authorized SeaLife dealer.

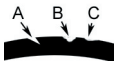

Inspect and replace O-ring if damaged: A=Cut, B=Tear, C=Dent

2. Carefully inspect and **clean O-ring and O-ring contact surfaces** for sand, hair and other debris **before every use.**

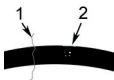

Inspect and clean O-ring and O-ring contact surface for hair or fibers (#1) and Sand, Salt or debris (#2)

3. Make sure O-ring is completely seated into O-ring groove before sealing housing. O-ring must not be twisted when seated in the o-ring groove.

4. Replace O-ring every year to ensure proper seal. Only use approved SeaLife O-ring (item #SL32018) designed for this camera. Replacement O-rings are available at your local authorized SeaLife dealer.
5. After each use underwater:
  - a. Soak sealed camera in fresh water for about 15 minutes. Most dive boats offer special fresh water buckets specifically for underwater photo equipment. DO NOT put camera in fresh water designed for other dive equipment, like dive mask, because that water may contain detergents which are harmful to the camera.
  - b. Push all the control buttons several times while camera is soaking to clean out any salt water, sand or dirt that has accumulated during usage.
  - c. Use clean, soft cloth to dry camera. You and the camera must be dry before opening waterproof door.



**NOTE**

- To protect your SeaLife camera from a build up of moisture, insert a Moisture Muncher® (item SL911) into the battery compartment during storage. Replace Moisture Muncher when the capsule turns pink. To order more, contact a SeaLife Dealer. For a list of dealers, visit: [www.sealife-cameras.com](http://www.sealife-cameras.com).





## How to Install and Remove O-ring

To **remove O-ring**, use a non-sharp object, like a credit card to lift up O-ring at one of the corners.



To **Install O-ring**, carefully push O-ring into groove, making sure to align the shape of the o-ring with the shape of the groove. Be careful not to twist the O-ring.



## How to Install Deflector

The deflector is only used in combination with the optional external flash accessory (item # SL960D). It will deflect the camera's flash to the external flash light sensor, which will then fire the external flash.

Insert deflector into External Flash base as shown.

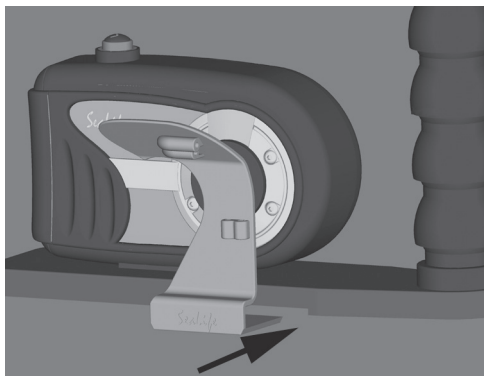

### NOTE

- Refer to instruction manual provided with optional external flash for detailed instructions and troubleshooting tips on using the optional external flash.
- See your local Sealife dealer or visit [www.sealife-cameras.com](http://www.sealife-cameras.com) to locate dealer near you.

## How to Install Deflector

This deflector can adapt the optional Flash Link optical cable (item # SL962). The optical cable is recommended to ensure that the external flash fires in all light conditions.

Insert optical cable through the holes as shown below.

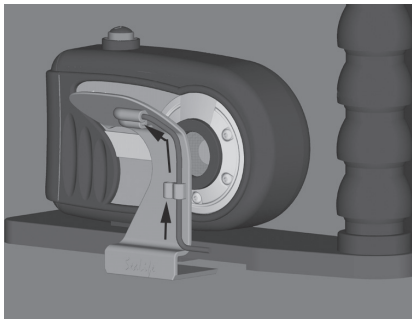

With end of cable pointing at the camera's flash, lightly tighten Allen screw with wrench provided until cable is secure.

Caution: Do NOT over tighten screw.

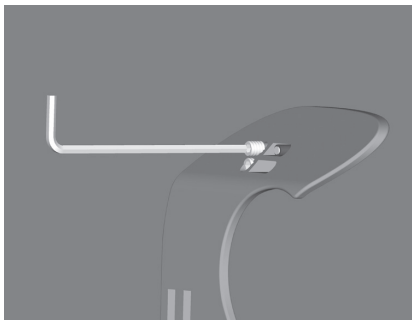

## Using and cleaning camera underwater

### Entering the water with camera

1. Do not jump into the water with camera in your hand. Have someone hand you the camera after you have entered the water.
2. For tips on taking pictures, see “**Great Underwater Pictures Made Easy**”.

### After using camera underwater

1. Before entering dive boat, hand the camera to someone on the boat.
2. Make sure the sealed camera is placed in a fresh water tank available on most dive boats. This will clean the salt water from the camera and prevents the salt water from drying on the camera and O-ring. Never let salt water dry on the camera. Salt crystals can damage the O-ring, lens and attract moisture. Dry camera with clean soft towel after removing from fresh water tank.
3. Do not expose camera to direct sunlight – keep in a shaded area or under a dry towel.
4. It is not recommended to open waterproof door while on the dive boat. Allowing humid air to enter the camera may cause fogging.
5. If you must open the camera while on the dive boat, make sure you and the camera are perfectly dry before opening the waterproof door. Do not allow the inside of the camera to get wet.

### Cleaning camera after use

1. The sealed camera must be thoroughly cleaned with fresh water before opening. Never let salt water dry on camera. Salt crystals may damage the O-ring, lens and attract moisture.
2. Never let water drops dry on lens. Wipe lens dry with clean cotton cloth.
3. Before opening camera, everything, including your hands, head and surrounding area must be totally dry. Have a dry towel handy.

### Prepare camera for storage

1. Before storing the camera, remove batteries, SD card and keep in a clean dry area. Make sure the camera and any accessories are clean and dry before storage.
2. Never store camera in direct sunlight or in a dark damp area. The airtight, unbreakable SeaLife ReefMaster Dry Case (Item # SL930) is highly recommended along with 1-oz bags of SeaLife Moisture Muncher Desiccant (Item # M101) for travel and storage.
3. To protect your SeaLife camera from build up of moisture insert a Moisture Muncher® (item #SL911) into the battery compartment during storage (see Page 52).

## Great Underwater Pictures Made Easy

Taking underwater pictures is much different than taking land pictures. Here are the most important tips to taking great pictures underwater:

### 1. Crystal Clear water.

Crystal Clear water is essential for good underwater pictures. Remember the human eye can see more detail than a camera. In other words, your eyes see the water as being clearer than it actually is. Floating particles like algae, and silt cause low visibility. Avoid stirring up the sandy bottom with your fins. These floating particles cause small spots to appear in your picture, known as “backscatter.” Always remember to limit your shooting distance to 1/10 of the water visibility. For example, if the visibility is 60 feet (18 m), you should keep your shooting distance to within 6 feet (1.8m); in 30 feet (9 m) visibility you should be no further than 3 feet (90 cm) away from your subject.

### 2. Stay within the ideal shooting distance of 2 to 6 feet.

The ideal shooting distance is between 2 to 6 feet (0.6 to 1.8 meters). This distance will result in detailed, colorful pictures. Remember that light does not travel very far underwater, so the closer you are to your subject the more colorful the pictures will be. For best most colorful pictures, we advise using the optional SeaLife External (SL960) or Digital (SL960D) Flash.

### 3. Move calmly and control your buoyancy before taking a picture.

It is very hard to take good pictures when you are moving. Look around for great picture opportunities. First position yourself at the best angle, and neutralize your buoyancy. Second, use the LCD monitor to perfectly frame your subject, check your shooting distance and keep the camera steady. Third, be calm and patient: Sometimes you have to wait a little bit so the fish that were frightened away, come back. Don't chase the fish, let the fish come to you.





*Always be in control of your buoyancy before taking pictures and observe all safe-diving rules.*

**4. Shoot many pictures of the same subject - If you don't like it, delete it - later.**

One of the great advantages of digital cameras is that you can review and delete pictures later, so shoot several pictures of the same subject. One of the best ways to learn underwater photography is from your good pictures and bad pictures.

**5. Evaluate picture for proper exposure and adjust exposure compensation as needed.**

Refer to section in this manual titled "Exposure Compensation" for more details. If using the Ext. Flash mode and optional flash accessory, select Macro Flash [] to darken picture. Select for Far Flash [] to brighten picture. You can also reduce the flash intensity (with the optional SL960D SeaLife Digital accessory) to brighten or darken the picture.

**6. Use Mini Wide Angle Lens for dramatic pictures.**

The Wide Angle lens (item # SL973) allow you to get close to your subject for images full of colors and razor-sharp details.

**7. Use the SeaLife Flash Accessories to enhance color and brightness.**

Water filters out light and red/yellow colors resulting in darker, bluer images. The only way to prevent this from occurring is by taking pictures at shallow depths (within 10-15' depth on a sunny day) or by using artificial light, like the SeaLife External (SL960) or Digital (SL960D) Flash. The Flash easily mounts to the bottom of the camera. The flexible arm allows you to direct the flash at the subject. Even two flashes can be mounted onto the camera for an evenly illuminated and shadow-free image. This system blocks the built-in flash and prevents backscatter. The flexible flash arms allow quick adjustments of the flash. An optional Flash Diffuser can be snapped onto the flash head and is highly recommended for closeup shots of bright, reflective subjects.

**8. Visit the SeaLife website for updated tips and advice.**

Any updates to the manual or additional tips and advice can be found on the SeaLife website at [www.sealife-cameras.com](http://www.sealife-cameras.com). You will find a helpful online guide with more details about underwater photography.

# TRANSFERRING FILES FROM YOUR DIGITAL CAMERA TO COMPUTER

## System Requirements (Windows)

- Pentium III 600 MHz or higher
- Windows 2000/ME/XP or later
- 64MB RAM
- 128MB hard disk space
- CD-ROM drive
- Available USB port

## System Requirements (Macintosh)

- PowerPC G3/G4
- OS 9.0 or later
- 64MB RAM
- 128MB hard disk space
- CD-ROM drive
- Available USB port

## Step I: Connect the digital camera to your computer

1. Connect one end of the USB cable to the USB port of the camera.
2. Connect the other end of the USB cable to an available USB port on your computer.
3. Push and hold the **OK** button on the camera until the power turns on.
  - The USB screen appears on the LCD display.
4. Use the **▲** / **▼** to select [PC], then press the **OK** button.
5. From the Windows desktop, double click on "My Computer".
6. Look for a new "Removable disk" icon. This "Removable disk" is actually the memory card in your camera. Typically, the camera will be assigned drive letter "e" or higher.
7. Double click on the removable disk and locate the DCIM folder.
8. Double click on the DCIM folder to open it to find more folders.
  - Your recorded images and video clips will be inside these folders.
  - Copy & Paste or Drag-N-Drop image and video files to a folder on your computer.

(For Mac users, double-click the "untitled" or "unlabeled" disk drive icon on our desktop. iPhoto may automatically launch.)

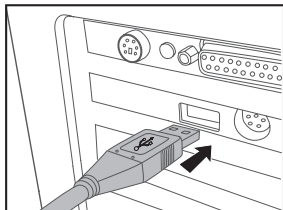



## Step 2: Download images or video clips

When the digital camera is turned on and connected to your computer, it is considered to be a disk drive, just like a floppy disk or CD. You can download (transfer) images by copying them from the “Removable disk” (“untitled” or “unlabeled” disk on a Macintosh) to your computer hard drive.

### ■ Windows

Open the “Removable disk” and double click on the DCIM / DSCIM folder to open it to find more folders. Your images are inside these folder(s). Select the desired still images or video clips and then choose “Copy” from the “Edit” menu. Open the destination location (folder) and choose “Paste” from the “Edit” menu. You may also drag and drop image files from the digital camera to a desired location.

### ■ Macintosh

Open the “untitled” disk icon, and the destination location on your hard disk. Drag and drop from the digital camera to the desired destination.



#### NOTE

- Memory card users may prefer to use a memory card reader (highly recommended).
- Video playback application is not included with the package. Make sure that video playback application has been installed in your computer.
- Make sure batteries have a full charge before connecting the camera to the computer.

# EDITING SOFTWARE INSTALLATION

## Installing Photo Explorer

Ulead® Photo Explorer provides a simple and efficient way to transfer, browse, modify and distribute digital media. Acquire photos, video or sound clips from various digital device types and easily browse or add personal descriptions; make timely modifications; or distribute the media through the medium of your choice: E-mail, Print, Slideshow Presentations. It is an indispensable all-in-one tool for owners of digital cameras, WebCams, DV camcorders, scanners, or anyone who strives to effectively organize a large collection of digital media.

1. Insert the enclosed CD-ROM into your CD-ROM drive.
2. When the welcome screen appears, click **“INSTALL PHOTO EXPLORER 8.0”**. Follow the on-screen instructions to complete the installation.



### NOTE

- For more information about the operation of Photo Explorer application software, refer to its respective help documentation.
- For Windows 2000/XP users, please make sure to install and use the Photo Explorer in “Administrator” mode.
- Photo Explorer is not supported on Mac. iPhoto or iPhoto2 is recommended.

## Installing Photo Express

Ulead® Photo Express is complete photo project software for digital images. The step-by-step workflow, visual program interface, and in-program help assist users in creating exciting photo projects. Acquire digital photos effortlessly from digital cameras or scanners. Organize them conveniently with the Visual Browse mode. Use hundreds of ready-to-use templates such as albums, cards, posters, slideshows, and more. Edit and enhance images with photo editing tools, photographic filters, and special effects. Embellish projects by adding creative design elements such as frames, callouts, and stamp objects. Share results with family and friends via e-mail and multiple print options.

1. Insert the enclosed CD-ROM into your CD-ROM drive.
2. When the welcome screen appears, click **“INSTALL PHOTO EXPRESS 5.0”**. Follow the on-screen instructions to complete the installation.



- For information on how to use Photo Express to edit and retouch your recorded images, please refer to its online help.
- For Windows 2000/XP users, make sure to install and use the Photo Express while logged in as a user with an Administrator account.
- Photo Express is not supported on the Mac.
- It's recommended to set the computer display color to full color views (32 bit) when the users use the Photo Express software.

## USING THE DIGITAL CAMERA AS A PC CAMERA

Your digital camera can act as a PC camera, which allows you to videoconference with business associates, or have a real-time conversation with friends or family. To use the digital camera for videoconferencing, your computer system must include the items as below:

- Microphone
- Sound card
- Speakers or headphones
- Network or Internet connection



### NOTE

- Video conferencing (or video editing) software is not included with the digital camera.
- This mode is not supported for Mac.

### Step 1: Install the PC camera driver

The PC-camera driver included in the CD-ROM is exclusively for Windows. The PC camera function is not supported for Mac platforms.

1. Insert the enclosed CD-ROM into your CD-ROM drive.
2. When the welcome screen appears, click **“INSTALL PC-CAM DRIVER”**. Follow the on-screen instructions to complete the installation.
3. After the driver installation is completed, restart your computer.

## Step 2: Connect the digital camera to your computer

1. Connect one end of the USB cable to the USB port of the camera.
2. Connect the other end of the USB cable to an available USB port on your computer.
3. Push and hold the **OK** button on the camera until the power turns on.
  - The USB screen appears on the LCD display.
4. Use the ▲ / ▼ to select [PC Camera], then press the **OK** button.
5. Position the digital camera steadily on top of your computer monitor or use a tripod.



### NOTE

- When using this digital camera as a PC camera, it is necessary to install the battery into the digital camera.

# MENU OPTIONS

## Camera Menu

This menu is for the basic settings to be used when capturing still images.

1. Press the **OK** button and hold it until the camera turns on.
  - The camera mode (default preview) is displayed.
2. Press the **▲** / **[ ]** button.
  - The [Capture] menu is displayed.
3. Select the desired option item with the **▲** / **▼** buttons, then press the **OK** button to enter its respective menu.
4. Select the desired setting with the **▲** / **▼** buttons, then press the **OK** button.
5. To exit from the menu, press the **◀** button.

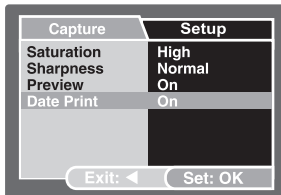
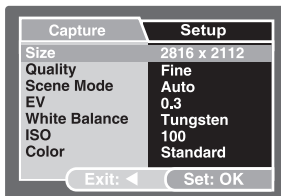

### Size

This sets the size of the image that will be captured.

- \* [  ] 2816 x 2112
- \* [  ] 2272 x 1704
- \* [  ] 1600 x 1200
- \* [  ] 640 x 480

### Quality

This sets the quality (compression rate) at which the image is captured.

- \* [  ] Fine
- \* [  ] Standard
- \* [  ] Economy

### Scene Mode





Refer to section in this manual titled “Scene Mode Selection” for further details.

## EV

Refer to section in this manual titled “Adjusting the Exposure (EV Compensation)” for further details.

## White Balance

This sets the white balance capturing under a variety of lighting conditions and permits images to be captured that approach the conditions that are seen by the human eye.

- \* [ **Blank** ] Auto
- \* [  ] Daylight
- \* [  ] Cloudy
- \* [  ] Tungsten
- \* [  ] Fluorescent
- \* [  ] Manual WB



### NOTE

- In Sea mode the following balance options are displayed:
  - \* Auto/less than 25 feet/8m (< 25ft/8m)/more than 25 feet/8m (> 25ft/8m)/Manual WB.Select the appropriate underwater depth for best white balance.
- Underwater color correction is most effective when there is sufficient ambient light. It will become increasingly difficult to correct for colors below 50ft/16m depth.

**Manual WB**-This manually sets the white balance and stores it. Use of this is convenient when the white balance does not offer a good match. Refer to section in this manual titled “Setting Manual White Balance” for further details.

- \* Cancel / Execute



### NOTE

- Do not make manual white balance adjustments when in Ext. Flash mode or the colors will not be correct.

## ISO

This sets the sensitivity for capturing images. When the image sensor sensitivity is raised (and the ISO figure is increased), photography will become possible even in dark locations, but the more pixelated (grainier) the image will appear.

- \* Auto / 50 / 100 / 200

## Color

This sets the color of the image that will be photographed.

- \* Standard / Vivid / Sepia / Monochrome

## Saturation

To capture an image, your camera offers you three different degrees of color to match with your preference. Your images will demonstrate different impression by selecting different degrees of color. This is called "Saturation".

- \* High / Normal / Low

## Sharpness

This sets the sharpness of the image that will be photographed.

- \* Hard / Normal / Soft

## Preview

This sets whether or not to display the captured image on the screen immediately after the image is captured.

- \* On / Off



### NOTE

- When [Preview] is set to [On], an instant delete screen will appear after each image is captured.
  - Select [Execute] and press the **OK** button to delete the image.
  - Select [Cancel] and press the **OK** button to save the image and return to the capture mode.
- If no option is selected, the instant delete screen will disappear automatically and the image is saved.

## Date Print

The date of recording can be printed directly on the still images. This function must be activated before the image is captured.

- \* On / Off



## Video Menu

This menu is for the basic settings to be used when recording video clips.

1. Push and hold the **OK** button until the camera turns on.
2. Toggle the **▼ / MODE** button and switch to [📷] mode.
3. Press the **▲ / [Menu]** button.
  - The [Video Output] menu is displayed.
4. Select the desired option item with the **▲ / ▼** buttons, then press the **OK** button to enter its respective menu.
5. Select the desired setting with the **▲ / ▼** buttons, then press the **OK** button.
6. To exit from the menu, press the **◀** button.

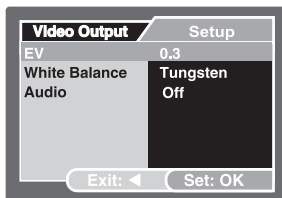

### *EV*

Refer to section in this manual titled "EV" in Camera Menu for further details.

### *White Balance*

Refer to section in this manual titled "White Balance" in Camera Menu for further details.

### *Audio*

This sets whether to record video clips with audio and sets the volume.

- \* High / Low / Off

## Playback Menu

In the [▶] mode, set which settings are to be used for playback.

1. Press the [▶] button.
2. Press the ▲ / [ ] button.
  - The playback menu is displayed.
3. Select the desired option item with the ▲ / ▼ buttons, then press the **OK** button to enter its respective menu.
4. Select the desired setting with the ▲ / ▼ buttons, then press the **OK** button.
5. To exit from the menu, press the ◀ button.

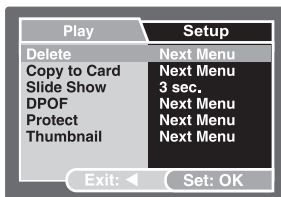

### Delete

Refer to section in this manual titled “Deleting Images/Video Clips” for further details.

### Copy to Card

Allows you to copy your files from the digital camera’s internal memory to a memory card. Of course, you can only do this if you have a memory card installed and some files in internal memory.

\* Cancel / Execute

### Slide Show

Refer to section in this manual titled “Slideshow Display” for further details.

### DPOF

Refer to section in this manual titled “Setting the DPOF” for further details.

### Protect

Refer to section in this manual titled “Protecting Images/Video Clips” for further details.

### Thumbnail

Refer to section in this manual titled “Thumbnail Display” for further details.

## Setup Menu

Set your camera's operating environment.

1. Toggle the **▼ / MODE** button and switch to camera or video [ ] mode, or press the [ ] button.
2. Press the **▲ / [ ]** button and access the setup menu with the **▶** button.
  - The [Setup] menu is displayed.
3. Select the desired option item with the **▲ / ▼** buttons, and press the **OK** button to enter its respective menu.
4. Select the desired setting with the **▲ / ▼** buttons, and press the **OK** button.
5. To exit from the menu, press continuously the **◀** button.

### *Date/Time*

This sets the date and the time.

Refer to section in this manual titled "Setting the Date and Time" for further details

### *Format*

Erases all images and reformats the SD card loaded in your camera. Protected images are also erased. SD card cannot be formatted if it is write-protected. Refer to section in this manual titled "Formatting an SD Memory Card or Internal Memory" for further details.

### *Beep*

This sets whether or not to mute the camera sound each time you press the camera button.

\* On / Off

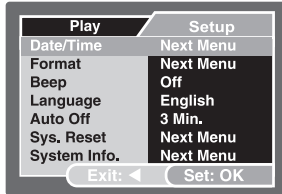
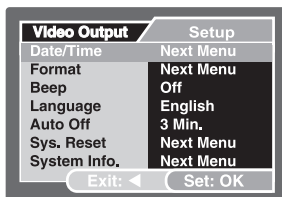
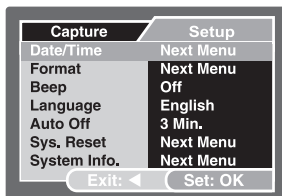

### ***Language***

Refer to section in this manual titled "Choosing the Screen Language" for further details.

### ***Auto Off***

If no operation is performed for a specific period of time, the power to the camera is automatically turned off. This feature is useful to reduce battery wear.

\* 3 Min./ 5 Min./ 10 Min./ Off

### ***Sys. Reset***

This returns all basic settings to the camera's default settings. The time setting will not be reset.

\* Cancel / Execute

### ***System Info.***

This displays the current firmware version of the camera.

# SPECIFICATIONS

Item	Description
Image Sensor	CCD
Effective pixels	6.0 Mega pixels
Image size	Still image: 2816 x 2112, 2272 x 1704, 1600 x 1200, 640 x 480 Video clip: 320 x 240
Image quality	Still image: Fine, Standard, Economy
Recording media	16MB internal memory (14MB available for image storage) SD memory card (Optional, up to 1GB)
File format	Image format: JPEG; video format: Motion JPEG (AVI)
Lens	F-no.: 3.3 Focal length: 6.95mm (equivalent to 42mm in 35mm camera)
Focus range (LAND)	Macro: 60 ~ 100cm (2ft to 3ft) Normal: 100cm~infinity (3ft to infinity)
Focus range (UW)	Macro: 45cm to 75cm (1.5ft to 2.5ft) Normal: 75cm to infinity (2.5ft to infinity)
LCD monitor	2.0" LTPS color LCD High-resolution 75K pixels display
Self-timer	10 sec delay, 2 sec delay, 10+2 sec delay
Exposure compensation	-2.0EV~ +2.0EV (in 0.3EV increments)
White balance	Auto, Daylight, Cloudy, Tungsten, Fluorescent, Manual WB, < 25ft/8m, > 25ft/8m
ISO	Auto, 50, 100, 200
Interface	USB connector
Power	2 x AA Alkaline batteries (Optional)
Dimension	Approx.75mm x 120mm x 43mm (3" x 4.7" x 1.7")
Weight	Approx.230g (without batteries and the SD memory card)
Depth rating	ECO shot:75'/23m Reefmaster mini: 130ft/40m
Shock rating	6ft/2m

\* Design and specifications are subject to change without notice.



## NOTE

- For more detailed specifications, please refer to the SeaLife website at [www.SeaLife-cameras.com](http://www.SeaLife-cameras.com).

# TROUBLESHOOTING

Refer to the symptoms and measures listed below before sending the camera for repairs. If the problem persists, contact your local reseller or SeaLife service center in your country. For a complete listing of service centers in your country visit [www.SeaLife-cameras.com](http://www.SeaLife-cameras.com).

## Power Supply

Symptom	Cause	Measure
The power does not come on.	The batteries are not loaded.	Load the batteries correctly.
	The batteries are exhausted.	Recharge or replace the batteries.
The power cuts out during use.	The camera was left unattended and unused, so the auto power off cuts it off.	Turn the power back on.
	The batteries are exhausted.	Recharge or replace the batteries.
The power does not go off.	Camera malfunction.	Reload the batteries.
The batteries run out quickly.	It is being used in extreme low temperature.	
	Many shots are being captured in dark places inside, requiring flash.	
	The batteries are not fully charged. The batteries are not used for an extended period of time after charged.	Fully charge the batteries and discharge them for at least one complete cycle before use to maximize its performance and lifetime.
The batteries or camera feels warm.	Long period of continuous use of the camera or the flash.	

## Shooting

Symptom	Cause	Measure
Even if I press the shutter button, the camera does not shoot.	The batteries are running low.	Recharge or replace the batteries.
	The power is not on.	Turn the power on.
	The camera is not in shooting mode.	Press the playback (▶) to switch to shooting mode.
	The shutter button is not pressed all the way.	Press the shutter button all the way.
	The memory card does not have any free space.	Load a new card, or delete unwanted files.
	End of memory card life.	Load a new memory card.
	The flash is recharging.	Wait until the status LED off.
	The memory card is unrecognized by the camera.	Format the memory card in this camera before its first use or when it was used other than this camera.
	The auto power off function is activated.	Turn the power on again.
	The memory card is write-protected.	Remove the write-protection.
Images do not appear on the LCD monitor.	The power is not on.	Turn the power on.

Symptom	Cause	Measure
The flash does not fire.	The flash is set to flash off.	Set the flash to something other than flash off mode.
	The flash is not ready or charged.	It takes approximately 4 seconds for the camera to recharge the flash. Wait for LED indicator light to be solid green.
	The flash is set to Auto and there is enough surrounding light.	Consider setting the flash to ON to force the flash in bright light.
Even though the flash fired, the image is dark.	The distance to the subject is greater than flash effective range.	Get closer to your subject and shoot.
The image is too dark.	The image was captured in a dark place while set to flash off.	Set the flash to something other than flash off mode.
	It is under-exposed.	Set the exposure compensation to a larger value. In Ext. Flash mode, set camera to far flash to make images brighter.
The image is too bright.	It is over-exposed.	Set the exposure compensation to a smaller value. In Ext. Flash mode, set camera to macro flash to make images darker.
The image lacks natural color. (Land only)	The image was captured in conditions that are hard for Auto White Balance to adjust to.	Manually set select white balance.
The underwater image is blue and lacks color.	Water filters out red and yellow colors.	Set camera to Sea mode and select appropriate white balance.
		Use optional external Flash accessory to restore lost colors.



## Playback

Symptom	Cause	Measure
Cannot playback.	It is not set to playback mode.	Press the playback (▶) button.
The contents of memory card cannot be replayed.	You played back a memory card that was not formatted by this device.	Loaded a card that was formatted and stored on by this device.
Files cannot be deleted.	The file is protected.	Cancel protection.
	You played back a memory card that was not formatted by this device.	Loaded a card that was formatted and stored on by this device.
Cannot format a memory card.	The memory card is write-protected.	Remove the write-protection.
	End of memory card life.	Load a new memory card.

**SL32025**

**January 2007**

9EQ39-4000-00